



GAMME DRIVERS DIMMABLE & STANDARDS



DRIVERS ON/OFF

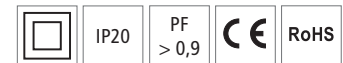

	PUISSANCE	PRIMAIRE	SECONDAIRE	VARIATION	TA	TC MAX	PRODUITS COMPATIBLES	DIMENSIONS	POIDS	GARANTIE	CODE
	10 W	0,06A 198..264Vac 50/60Hz	500mA 14..20V 7..10W	ON/OFF	-25°C / +50°C	80°C	Powerlight COB	102x51x22mm	61 g	5 ans	LC10W500
	25 W	0,04..0,11A 110..277V 50/60Hz	700mA 12.36Vdc 8,5..25W	ON/OFF	-20°C / +45°C	80°C	LuciPanel 300x300 / 300x600 LuciPanel.fr 600x600	131x38x29mm	115 g	3 ans	LC125/700-A-UN
	35 W	0,07A 100..277Vac 50/60Hz	700mA 36..48Vdc 25..35W	ON/OFF	-20°C / +40°C	80°C	LuciPanel 675x675 / 1200x200 / 1200x300 / 1200x200 double face	145x43x29mm	170 g	3 ans	STD024A
NORMES	LC10W500 : EMC EN55015 - EN61000-3-2 - EN61000-3-3 - EN61547 / LVD EN61347 - EN62384 LC125/700-A-UN & STD024A : EMC EN55015 - EN61000 classe C - EN61547 / LVD EN61347 - EN62493 - EN62560										

DRIVERS 1-10V



	PUISSANCE	PRIMAIRE	SECONDAIRE	VARIATION	TA	TC MAX	PRODUITS COMPATIBLES	DIMENSIONS	POIDS	GARANTIE	CODE
	10 W	0,06A 198..264Vac 50/60Hz	500mA 10..20V 5..10W	Coupe de phase montante et descendante et variation 1-10V	-20°C / +40°C	60°C	Powerlight COB	102x51x30mm	61 g	5 ans	LCBI10W500
	40 W	0,23A 180..295Vac 50/60Hz	350 / 500 / 600 / 700 / 900 / 1050 mA 0..40W	1-10V	-30°C / +60°C	90°C	Luminaire de la gamme jusqu'à 40W	124x82x23mm	190 g	3 ans	LCM-40
	60 W	0,32A 180..295Vac 50/60Hz	500 / 600 / 700 / 900 / 1050 / 1400 mA 0..60W	1-10V	-30°C / +60°C -25°C / +45°C (900mA / 1050mA)	90°C	Luminaire de la gamme jusqu'à 60W	124x82x23mm	190 g	3 ans	LCM-60
NORMES	LCBI10W500 : EMC EN55015 - EN61000-3-2 - EN61000-3-3 - EN61547 / LVD EN61347 - EN62384 LCM-40 & LCM-60 : UL8750 / ENEC EN61347-1 - EN61347-2-13 - EN62384 - EN55015 - EN61000-3-2 - Class C - EN61000-3-3 - EN61000-4-2,3,4,5,6,8,11 - EN55024 - EN61547										

DRIVERS 1-10V : LCM-40 / LCM-60



Câblage

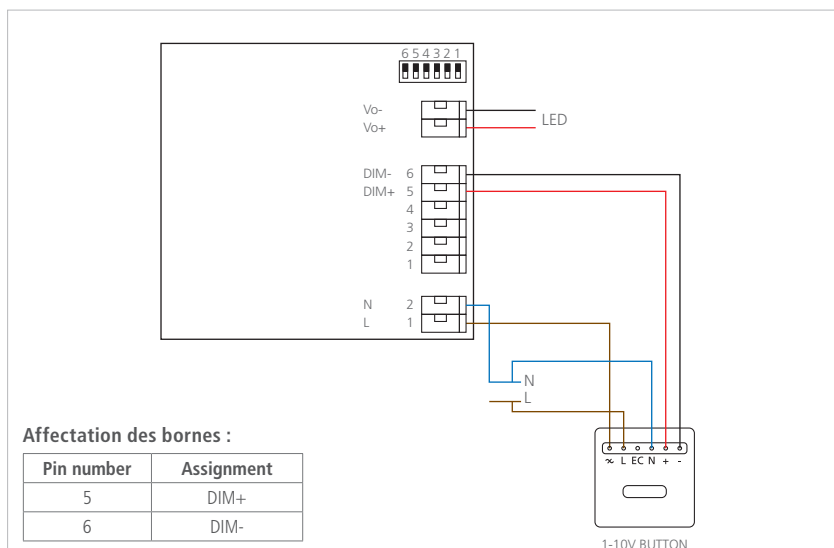

Pour LuciPanel :
Driver livré avec câble de connexion dédié 1W0065VB (+ = fils avec liseré blanc / - = fils transparent)

Accessoires (vendus séparément)

Câble de synchronisation CSDIM003B (longueur 4m) : synchronisation de plusieurs drivers dimmables (10 max) avec un seul bouton de commande (1 maître, 9 esclaves)



CSDIM003B - 11€ HT